

JC180144

ToughLED Pro CCT

ToughLED™ Pro 6ft 37/50/60/72W 3000K/4000K/5700K IP66 WOP

Features & Benefits

- Multi Wattage and CCT selectable
- 90° Lock-in-place side clip design, keeps clips clear during installation
- Detachable 4 pin terminal block with multiple positions adjacent to all cable entry points
- Inbuilt loop-in/loop-out cable restraints to ensure that cables do not clash when closing the fixture
- Plug & play emergency & microwave sensor modules with optional remote control
- Ultra-wide surface mount bracket rail to enable flexibility to locate joists
- Wide body for retrofitting BESA conduit box mounting, with rear, side and end conduit entry points
- Unique rear IP66 gasket, sealing cable entry from within the fixture for surface mounting applications
- 4ft, 5ft, 6ft single and twin light outputs in both opal and prismatic diffuser options
- Microwave step dimmable, DALI and 1-10V dimmable options available
- High efficiency up to 165 lpcW, IP66, IK10
- 5-year extended warranty on fixture and batteries

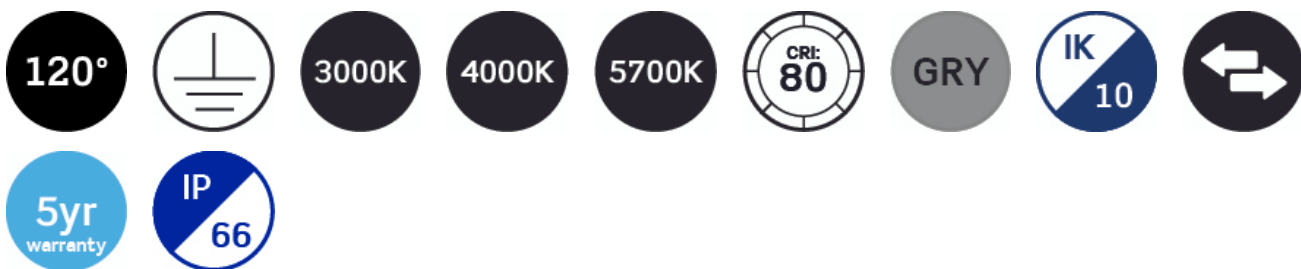

General Information

Mounting	Surface or Suspended
Trade Name	ToughLED™ Pro
Environment	Suitable for exterior and interior applications
Suitable For Zones	Zone 1
Product Group	LED - Surface
Color Finish	Grey
Product Shape	Rectangular
Product Range	ToughLED™ Pro
IK Rating	IK10

Overall Dimensions	1870 x 96 x 81.3
Length (mm)	1870
Width (mm)	96
Height (mm)	81.3
Product Weight(kg)	2.10
Light Source	LED
Light Source Features	3 CCT Selectable
Recommended product location	Wall or Ceiling Mount or suspended, suitable for a wide variety of applications. Including Warehouses/storage facilities. Car parks and manufacturing.
Method of fix	Mounting Brackets, Suspension chains or conduit mounting
Distance from lighted object	0.3m
IP Rating	IP66
Origin of manufacturer	Made in China
Warranty	5 Year Warranty (See Website for terms and conditions)
Driver manufacturer	JCC
LED manufacturer/type	Runlite/2835
Customs Tariff code**	9405494000

Electrical

Voltage Rating	220-240
Primary Running Current(Amp)	0.4
Inrush current(Amps)	<20A @240V
Operating Frequency Hz	50/60
Secondary running current(mA)	650/850/1050/1250
Constant Current or Constant Voltage	Constant Current
Luminaire Circuit Wattage1	37
Luminaire Circuit Wattage2	50
Luminaire Circuit Wattage3	60
Luminaire Circuit Wattage4	72
Class	I
Output Voltage Max/Range (VDC)	40-56
Total Harmonic Distortion (THD)%	<20
EMC Compliant (EN55015)	Yes
Power Factor Correction	0.9
Input Electrical Connections	Live, Earth, Neutral
Dimmable	No

Thermals

Thermal Cut Out	Yes
Operating Temperature Range °C	-20 to +50

Performance Data

LED Life (Hours)*	102000
-------------------	---------------

Energy Rating	This product contains a light source of energy efficiency class D
Actual Lumen Output1	5000
Actual Lumen Output2	6350
Actual Lumen Output3	8050
Actual Lumen Output4	9200
Lumens Per Circuit Watt1	135
Lumens Per Circuit Watt2	127
Lumens Per Circuit Watt3	134
Lumens Per Circuit Watt4	128
Standard Deviation Colour Matching - SDCM	<5
Color Rendering Index	80-89
CRI: Ra	80
Correlated Colour Temperature1	3000
Correlated Colour Temperature2	4000
Correlated Colour Temperature3	5700
Beam Angle °	120
LOR (Light Output Ratio) %	100
Photometry Available	Yes

Construction

Primary Material	Polycarbonate
Outer Diffuser	Polycarbonate
Driver Housing	Polycarbonate

Packaging

Product carton overall dimensions(cm)	187.5 x 10 x 8.5
Product Packaged Weight(kg)	2.36
Quantity Per Outer Carton	6
Outer carton(L)- cm	189
Outer carton(W)- cm	21.5
Outer carton(H)- cm	27
Outer carton Net weight- kg	14.14
Outer carton Gross weight- kg	15.04
Product Bar Code EAN-13 Number	5052544129803
Outer carton Bar Code ITF-14 Number	15052544129800

Standards & Approvals

Manufactured in accordance to	BS EN 60598:2015, 2-1
CE Marked	Yes
UKCA Marked	Yes
Date code/Purchase order No.	Yes
WEEE symbol	Yes
Certificate Of Conformity	Available on request
Accredited Members	LIA, ISO9001-2015, ISO14001-2015

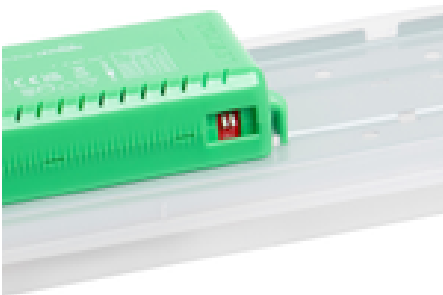
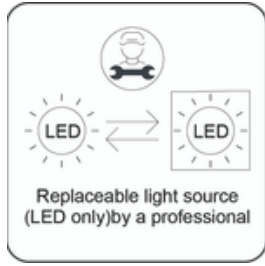
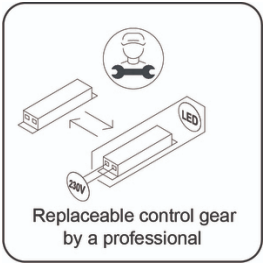
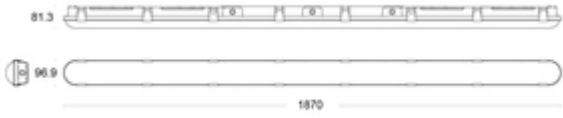

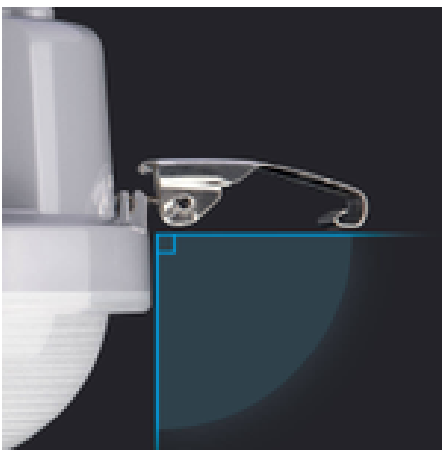

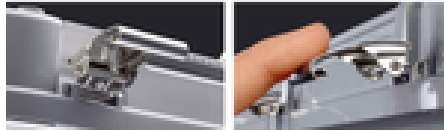

*Hours life stated is an indication of expected L70 chip and light output calculations when operating in optimum conditions. Product warranty period supports the full product during the term given. The L70 hours expectancy is not correlated with the full product warranty term, nor is it a representation of lumen depreciation during the warranty period.

**JCC Lighting Limited makes every effort to ensure that the Customs Tariff information in this document is timely and accurate. However, it's not possible for us to assure the absolute veracity and completeness of that information, as errors may occur. The placement of any inaccurate tariff information is completely unintentional. JCC Lighting Limited reserves the right, in its sole discretion, to correct any errors or omissions to the tariff code and to make any and all changes contained in this document at any time and without notice. It is the sole responsibility of the importer to ensure that the commodity code advised is correct for the products/goods being supplied by JCC Lighting Limited. JCC Lighting Limited does not assume any liabilities, losses, costs, and expenses arising out of or related to the importers use of this commodity code or the information related to the import of any JCC Lighting products.

JCC Lighting LTD, Lux Park, Chichester Business Park, City Fields Way, Tangmere, Chichester, West Sussex, PO20 2FT.
Sales: 01243 838999 (8am to 5pm Monday to Friday) Fax: 01243 838998 | sales@jcc.co.uk | www.jcc.co.uk
Company Registration Number: 03044848 | VAT Number: 918544112

This document is uncontrolled if printed, all information is subject to change

Version 132 [20/11/2025]